



EL640.480-AM Series
ICEBrite™ EL VGA Displays

USER'S MANUAL

www.planar.com

Contents

AM Series 10.4" VGA Flat Panel Displays	3
Features	3
Options	4
Installation and Handling.....	4
Mounting	4
Cable Length.....	5
Cleaning	5
Avoiding Burn-In	5
Specifications	6
Power.....	6
<i>Input Voltage Selection</i>	7
Connectors	7
<i>AM1 Data and Power Connector</i>	7
<i>AM8 Data and Power Connector</i>	8
<i>Locking Power and Data Connector</i>	9
<i>Dimming Connector J2</i>	9
Interfacing	9
<i>Video Input Signals</i>	10
Self-Test Mode.....	12
Optical Performance	13
<i>Dimming</i>	13
<i>Grayscale</i>	14
Reliability.....	14
Safety and EMI.....	14
Environmental.....	15
Mechanical Characteristics	15
Component Envelope	16
Description of Warranty	17
Ordering Information	18
Support and Service.....	18

Figures

Figure 1. AM1 Data/Power Connector.....	7
Figure 2. AM8 Connector Locations.....	8
Figure 3. Video Input Timing Diagram.....	10
Figure 4. Setup and Hold Timing Diagram.....	11
Figure 5. Data Format.....	12
Figure 6. AM Series Dimensions.....	16

Tables

Table 1. DC Input Voltage Requirements.....	6
Table 2. Video Input Requirements.....	6
Table 3. J1 Connector Pinouts.....	8
Table 4. Video Input Timing.....	10
Table 5. Setup and Hold Timing.....	11
Table 6. Optical Characteristics.....	13
Table 7. Environmental Characteristics.....	15
Table 8. Dimensions and Weight.....	15

AM Series 10.4" VGA Flat Panel Displays

This manual supports these Planar ICEBrite displays:

- EL640.480-AM1
- EL640.480-AM1 AG
- EL640.480-AM8 IN (Industrial version)
- EL640.480-AM8 ET (Extended Temperature version)
- EL640.480-AM8 ET CC (ET with conformally coated board)
- EL640.480-AM8 ETL (Extended Low Temperature version)
- EL640.480-AM8 ETL CC (ETL with conformally coated board)

The AM series of 10.4" diagonal VGA products offers designers an affordable and easily-implemented path to incorporate flat panel solutions to meet display requirements.

Utilizing Planar's proprietary ICEBrite technology (Integrated Contrast and Brightness Enhancement), these displays excel in ambient light environments ranging from dark rooms to nearly sunlight. This proprietary technology achieves very high contrast and exceptionally clear images. These displays are easy to integrate, enabling the quick replacement of existing LCDs. This family utilizes a common 8-bit FPD-type interface compatible with most LCD video controller chips. Up to five distinct gray levels are enabled by frame rate modulation algorithms generated by the controller chips.

Through simple design and advanced manufacturing technologies, Planar's new VGA displays bring the visual performance and image quality of electroluminescence (EL), long life, and ruggedness into cost-sensitive applications.

Features

- Excellent viewing characteristics
- High brightness and contrast
- Wide viewing angle
- Long life
- Extreme ruggedness
- Designed for low EMI
- Fast response time
- Lower power

Options

Anti-glare and conformal coating options are available on this display.

The anti-glare option adds an anti-glare film to the front of the display to reduce specular reflections (see Application Note 135 for more information).

The conformal coating option adds a protective layer to the display for applications in which the display may be subjected to high humidity, dust, or salt mist (see Application Note 122 for more information).

Installation and Handling

The mechanical package consists of the display panel and electronic circuit board bonded together, plus a protective cover carrying the display mounting ears. The display is made of glass material and must be handled with care.

CAUTION: The display uses CMOS and power MOSFET devices. These components are electrostatic sensitive. Unpack, assemble, and examine this assembly in a static-controlled area only. When shipping, use packing materials designed for protection of electrostatic-sensitive components.

Do not drop, bend, or flex the display. Do not allow objects to strike the surface of the display.

Mounting EL Displays

The EL640.480 AM displays were designed to facilitate the mounting of optical treatments and touchscreens on the viewing side of the display. To this end, the glass extends in front of the mounting bezel by approximately 0.5 mm (0.02 in.). It is imperative that any mounting scheme apply uniform pressure at all times across the glass. Pressure applied to the corners or edge of the glass is likely to cause breakage.

Mounting should be done using the mounting ears only. Use either metric M3 screws torqued to 350 Ncm maximum, or unified #4 screws torqued to 4.7 in/lb maximum.

CAUTION: Properly mounted, this display can withstand high shock loads and severe vibration in aggressive environments. However, the glass panel used in this display will break when subjected to bending stresses, high impact, or excessive loads.

To prevent injury in the event of glass breakage, a protective overlay should be used on the viewer side of the display.

WARNING: These products generate voltages capable of causing personal injury (high voltage up to 200 V_{ac}). Do not touch the display electronics during operation.

Cable Length

The maximum recommended cable length is 600 mm (24 in.). Longer cables may cause data transfer problems between the data transmitted and the display input connector. Excessive cable lengths can pick up and source unwanted EMI. There are third party products which allow this maximum cable length to be exceeded. Contact Planar Application Engineering for more information.

Cleaning

As with any glass or coated surface, care should be taken to minimize scratching. Clean the display glass with mild, water-based detergents only. Apply the cleaner sparingly to a soft cloth, then wipe the display. Disposable cleaning cloths are recommended to minimize the risk of inadvertently scratching the display with particles embedded in a re-used cloth. Particular care should be taken when cleaning displays with anti-glare and anti-reflective films.

The TAB (tape-automated bonding) leads between the electronics and the display glass are very sensitive to handling. When cleaning the edges of the display glass, special care should be taken not to damage the leads.

Avoiding Burn-In

As with other light emitting displays, displaying fixed patterns on the screen can cause burn-in, where luminance variations can be noticed. Use a screen saver or image inversion to avoid causing burn-in on the display.

Specifications

The EL panel is a matrix structure with column and row electrodes arranged in an X-Y formation. Light is emitted when an AC voltage of sufficient amplitude is applied at a row-column intersection. The display operation is based on the symmetric, line at a time data addressing scheme. Operating voltages required are provided by a DC/DC converter.

Unless otherwise specified, performance characteristics are guaranteed when measured at 25°C.

Power

The supply voltages required for the displays are shown in Table 1. All internal high voltages are generated from display supply voltage (V_H). The logic supply voltage (V_L) should be present whenever video input signals or V_H is applied.

Table 1. DC Input Voltage Requirements.

	AM1, AM8 ETL	AM8 IN/ET		Notes
		12 V	24 V	
V_L	+5 V \pm 5%	+5 V \pm 5%	+5 V \pm 5%	absolute max 7.0 V
V_H	+12 V \pm 10%	+12 V \pm 10%	+24 V \pm 10%	absolute max. 15 V and 30 V respectively
I_L , max	75 mA	75 mA	75 mA	@ V_L = +5 V
I_H , max	2.0 A	2.0 A	1.0 A	@ V_H = +12 V
P_{typ} , 120 Hz	11 W	11 W	11 W	3840 'E' characters
P_{max} , 120 Hz	24 W	24 W	24 W	50/50 2x2 checkerboard

CAUTION: Absolute maximum ratings are those values beyond which damage to the device may occur.

Table 2. Video Input Requirements.

Description	Min	Max	Notes
Video logic high voltage	3.7 V	5.0 V	All input thresholds are CMOS
Video logic low voltage	0 V	0.9 V	Video lines have 100 Ω series resistors
Video logic input current	- 10 μ A	+10 μ A	

There is no overcurrent protection on either the V_H or V_L inputs to protect against catastrophic faults. Planar recommends the use of a series fuse on the 12 volt supply. A general guideline is to rate the fuse at 1.8 to 2 times the display maximum current rating.

Input Voltage Selection

The AM8 displays (except AM8 ETL) feature a jumper that allows the user to choose between 12 and 24 volt supply voltage. The displays are shipped with the JP1 jumper in the pin 1/pin 2 position which sets the supply voltage at 12 volts.

To select a 24 volt supply, move the JP1 jumper to the pin2/pin3 position. Pin one is marked on the +12 V end of JP1.

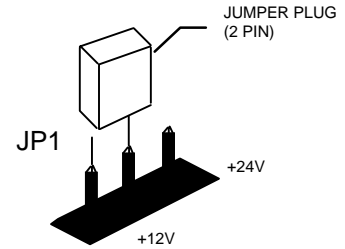

CAUTION: Providing a 24 volt supply to the display when the jumper is in the 12 volt supply position will damage the display.

The display will not function if the jumper is removed completely. Planar recommends the use of a non-conductive adhesive to secure the jumper in the desired position in environments where shock or vibration might loosen the jumper.

The minimum and maximum specifications in the manual should be met, without exception, to ensure the long-term reliability of the display. Planar does not recommend operation of the display outside these specifications.

Connectors

AM1 Data and Power Connector

The AM1 displays use the Samtec STMM-110-01-S-D or equivalent connector, and the AM8-IN displays use the Samtec STMM-110-01-T-D or equivalent connector. The mating connector for both the AM1 and AM8-IN displays is in the Samtec TCSD family of cable strips. The proper connector, user-specified cable length, and connector configuration are supplied as a single unit. Consult your Samtec representative (1 800-SAMTEC9) for the cable/connector options.

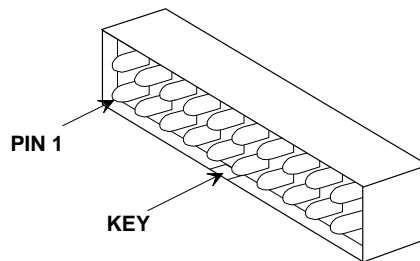

Figure 1. AM1 Data/Power Connector

AM8 Data and Power Connector

The standard data and power connector for the AM8 displays is a Samtec ASP-61606-01-M or equivalent, J1 20-pin, 2mm pitch (Figure 2. Connector Locations). The mating connector is in the Samtec TCSD family of cable strips. The proper connector, user-specified cable length, and connector configuration are supplied as a single unit. Consult your Samtec representative (1 800-SAMTEC9) for the cable/connector options.

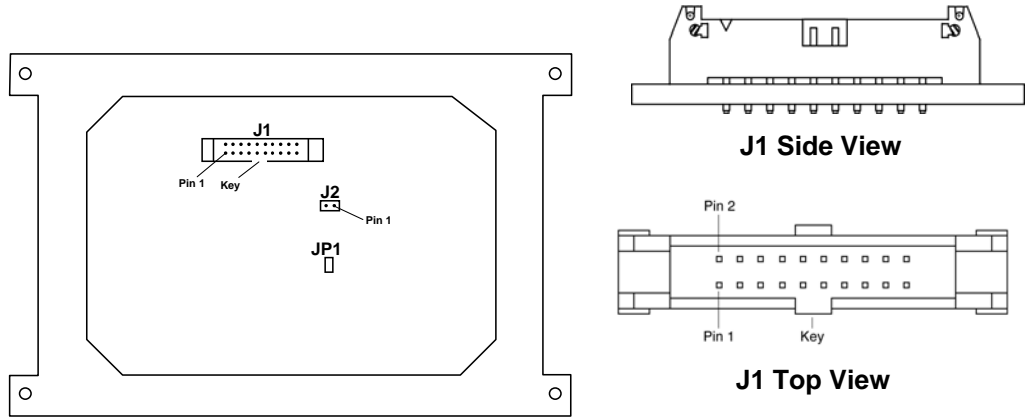

Figure 2. AM8 Data/Power Connector

Table 3. J1 Connector Pinouts.

Pin	Signal	Description	Pin	Signal	Description
1	UD1	Video data (upper)	2	UD0	Video data (upper)
3	UD3	Video data (upper)	4	UD2	Video data (upper)
5	LD1	Video data (lower)	6	LD0	Video data (lower)
7	LD3	Video data (lower)	8	LD2	Video data (lower)
9	CP2	Pixel clock	10	GND	Ground
11	CP1	Line pulse	12	GND	Ground
13	S	Frame pulse	14	GND	Ground
15	GND	Ground	16	GND	Ground
17	V _L	+5 V logic supply	18	V _L	+5 V Logic supply
19	V _H	+12/24 V Display supply	20	V _H	+12/24 V Display supply

Locking Power and Data Connector

The AM8 IN display may be ordered with an optional 20 pin, 2 mm through-hole locking male header, Samtec EHT-110-01-S-D or equivalent. **The locking connector is standard on the AM8 ET and AM8 ETL.** The locking connector adds 2.0 mm to the display depth.

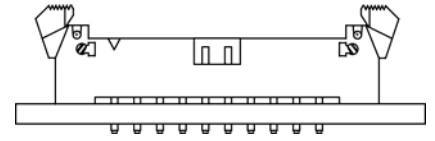

The Samtec mating connector for the non-locking power and data connector on the AM1 and AM8 IN will mate with the locking connector. Compatibility with non-Samtec equivalents should be verified before use.

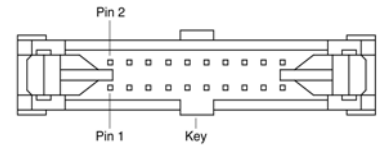

Dimming Connector J2

An analog dimming circuit is standard on the AM8. The J2 dimming connector is a Molex 2-pin, right angle locking male, part number 22-12-2024. The recommended mating connector is a Molex 22-01-3027 (housing) and 08-52-0123 (crimps, 2 per housing).

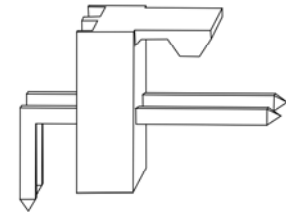

Additionally the crimp housing will need crimp terminals to connect the wires, Molex 2759 or 6459 can be used.

Molex crimp terminal 41527 is recommended for applications with high vibration requirements.

For a discussion of the dimming feature, refer to the Dimming section below, under Optical Performance.

Interfacing

This dual scan LCD-type video interface provides a low cost, flexible method for controlling display brightness and power consumption. Many off-the-shelf chipsets are available for interfacing to flat panel displays. If your application does not require chip-level integration, there are many vendors that can supply board-level solutions for serial control, PC104, ISA, and many other interfaces.

Planar Application Note 116 summarizes some of the interfacing options that have been used in the past with EL VGA displays.

Video Input Signals

The end of the top line of a frame is marked by S, scan start up signal as shown in Figure 3. The end of each row of data is marked by CP1 as shown in Figure 3 and Figure 4.

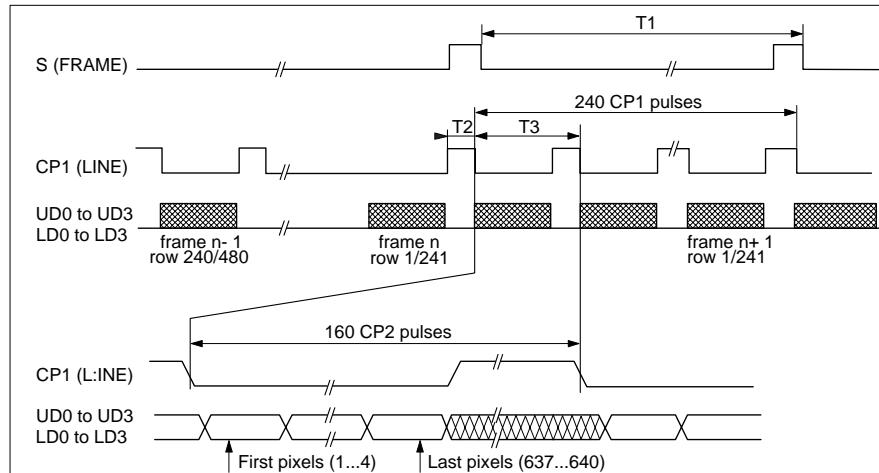

Figure 3. Video Input Timing Diagram.

Table 4. Video Input Timing.

Symbol	Name	Min	Max	Units
T1	Frame time	8.3	---	ms
	Frame frequency	---	120	Hz
T2	CP1 High time	60	---	ns
T3	CP1 Period	34.5	---	μ s

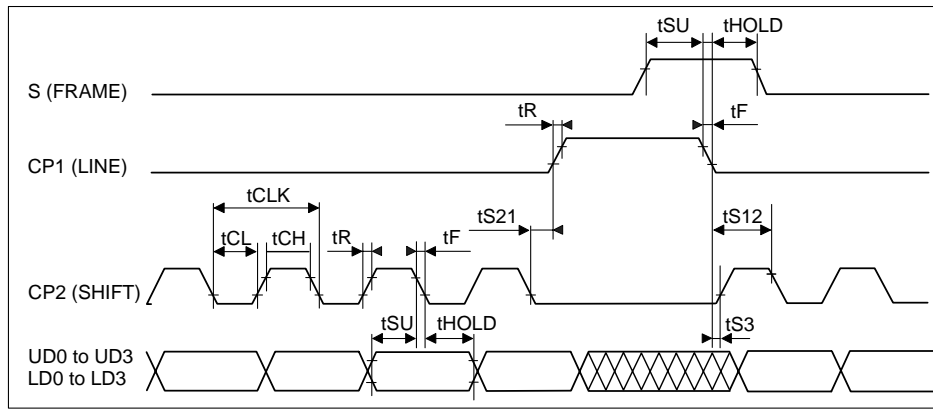

Figure 4. Setup and Hold Timing Diagram.

Table 5. Setup and Hold Timing.

Symbol	Name	Min.	Max	Unit
tS21	CP1 allowance from CP2	0		ns
tS12	CP2 allowance from CP1	200		ns
tS3	CP1 allowance to CP2	50		ns
tSU	Setup time	50		ns
tHOLD	Hold time	40		ns
tR	Rise time		30	ns
tF	Fall time		30	ns
tCLK	CP2 clock cycle	154		ns
tCL	CP2 clock low time	60		ns
tCH	CP2 clock high time	60		ns

Input signals **UD0** through **UD3** contain the video data for the upper screen and signals **LD0** through **LD3** contain the data for the lower screen. For example, four pixels (UD3:1,1–UD0:1,1) are sent to row 1 at the same time as four pixels (LD0:1,1–LD3:1,1) are sent to row 241. This results in eight pixels sent on each cycle of video clock **CP2**. Pixel information is supplied from left to right and from top to bottom. Video data for one row is latched on the fall of **CP1** (Figure 5).

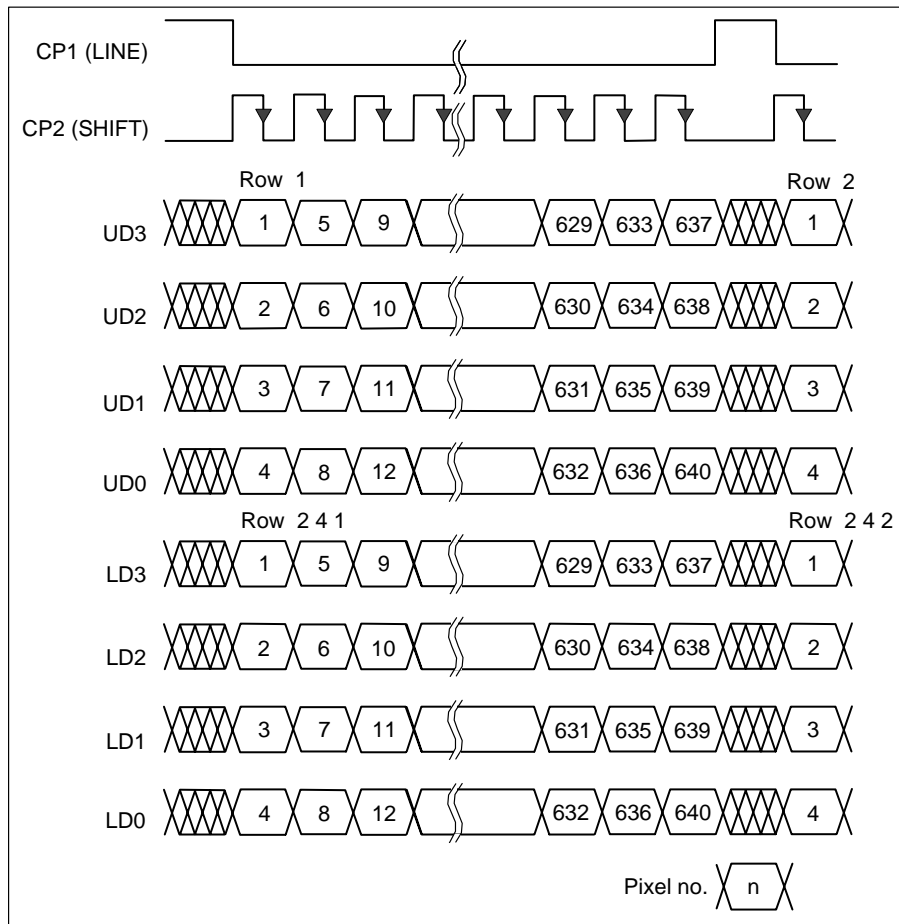

Figure 5. Data Format.

Self-Test Mode

The display incorporates a self-test mode composed of a 1x2 checkerboard pattern that inverts every few seconds. The self-test mode is entered by applying power to the display with the **S** signal static. The display remains in this mode until two (2) low-to-high transitions of the **S** signal are detected. The display then enters and remains in normal (user video driven) operation as long as power is applied. To enter self-test mode again, the display must be reset by cycling the **V_H** power input.

Optical Performance

Table 6. Optical Characteristics.

Luminance	L _{on} (areal), min	L _{on} (areal), typ	L _{off} (areal), max
AM1	40 cd/m ²	65 cd/m ²	0.3 cd/m ²
AM8 IN/ET/ETL	35 cd/m ²	49 cd/m ²	0.3 cd/m ²
Minimum and Typical: Center, 120 Hz frame rate			
Maximum: Center and four corners, 120 Hz frame rate			
Non-uniformity			
AM1	35%	All pixels fully on @120 Hz	
AM8 IN/ET/ETL	26%	Maximum difference two of five points, using the formula: BNU%=[1 - (min_lum/max_lum)] x 100%	
Luminance Variation (Temperature)			
Maximum	15%	Across operating temperature range	
Luminance Variation (Time)			
Maximum			
AM1	20%	10,000 hours at 25°C ambient	
AM8 IN/ET/ETL	10%	10,000 hours at 25°C ambient	
Viewing Angle			
Minimum	160°		
Contrast Ratio			
	Minimum	Typical	
AM1	19:1	40:1	
AM8 IN/ET/ETL	35:1	70:1	
Minimum: @ 500 lux ambient, @ 120 Hz frame rate			

Dimming

There are two standard methods for dimming the AM displays. Frame rate dimming allows the brightness of the display to be lowered proportionally by reducing the frame rate. Analog dimming allows the brightness to be reduced with an external, user supplied potentiometer or electronic circuitry. The brightness range for analog dimming is from 100% to nearly 5% of the full brightness.

Frame rate dimming is performed within the application by lowering the frame rate of the video input signals. Because brightness is proportional to refresh rate, the display can be dimmed by adding pauses between every horizontal period.

The lowest possible frame rate (brightness) is dependent on the perceived flicker of the displayed image, but will most likely be around 60 Hz. For more information on frame rate dimming please see Planar Application Note 120.

The analog dimming feature utilizes a 50k ohm logarithmic external potentiometer, allowing manual control of the display's brightness. Analog dimming is standard on the AM8 IN and AM8 ET displays. The typical current for minimum brightness is 220 µA.

Grayscale

Using the display's higher frame rate frequency, combined with flat panel controllers, it is possible to generate a wider range of usable grayscales through frame rate control and dithering.

Frame Rate Control generates true grayscales by turning pixels on and off over several frames of time. The user's eye sees each individual pixel as gray. The potential problems with this method are brightness-profile and shadowing, especially when used to shade larger areas.

Dithering generates grayscales by patterning the area to be shaded. The tested C&T controllers use a pattern of 4 (2x2) pixels to generate the dithered grayscales. When the area is viewed from a distance, it appears to the user's eye as gray. When viewed up close, the different brightness of the individual pixels can be observed.

Many of the grayscales that can be generated may flicker or swim. Through careful selection however, several grayscale patterns are available for most applications, particularly when the display is driven at its maximum frame rate frequency. Planar Application Note 119 is available for more information on generating grayscale images.

Reliability

The MTBF (mean time between failures) is a minimum of 50,000 hours at 25°C ambient, except for performance characteristics with an otherwise specified life expectancy.

Safety and EMI Performance

The AM displays will not inhibit the end product from obtaining these certifications:

Safety: UL544, IEC950

EMI: FCC Part 15/J, Class B
EN55022 Level B

Environmental

Table 7. Environmental Characteristics.

Temperature	AM1	AM8 IN	AM8 ET.....AM8ETL
Operating	-5 to +55°C	-25 to +65°C	-40 to +65°C.....-60 to +65°C
Non-Operating	-40 to +75°C	-40 to +75°C	-40 to +75°C.....-60 to +75°C
Operating Survival	-20 to +65°C	-40 to +70°C	-40 to +70°C.....-60 to +70°C
Humidity			
Non-condensing	93% RH max +40°C per IEC 68-2-3.		
Altitude			
	AM1	AM8	
Operating	0 to 5 km (16k ft)	0 to 18 km (58k ft)	
Non-Operating	0 to 18 km (58k ft) per IEC 68-2-13		
Vibration			
Random	0.02 g ² /Hz ASD level, 20-500 Hz per IEC 68-2-36, test Fdb		
Shock			
Half sine wave	100 g, 4 ms 18 (3 each, 6 surfaces) per IEC 68-2-27, test Ea		

Mechanical Characteristics

Table 8. Dimensions and Weight.

Display Size	266.0 x 192.0 (W x H)
Display Depth	20.0 (AM1), 15.8 (AM8 IN), 17.8 (AM8 ET/ETL)
Active Area	211.1 x 158.3 (W x H)
Fill Factor	57%
Pixel Pitch	0.33 x 0.33
Pixel Size	0.25 x 0.25
Weight (typical)	650 g

All dimensions are in millimeters, unless otherwise noted.

Component Envelope

Figure 6 illustrates the mechanical dimensions and the distance components extend behind the display. Tall components do not necessarily fill this area. Planar reserves the right to relocate components within the constraints of the component's envelope without prior customer notification. For this reason, Planar advises users to design enclosure components to be outside the component envelope.

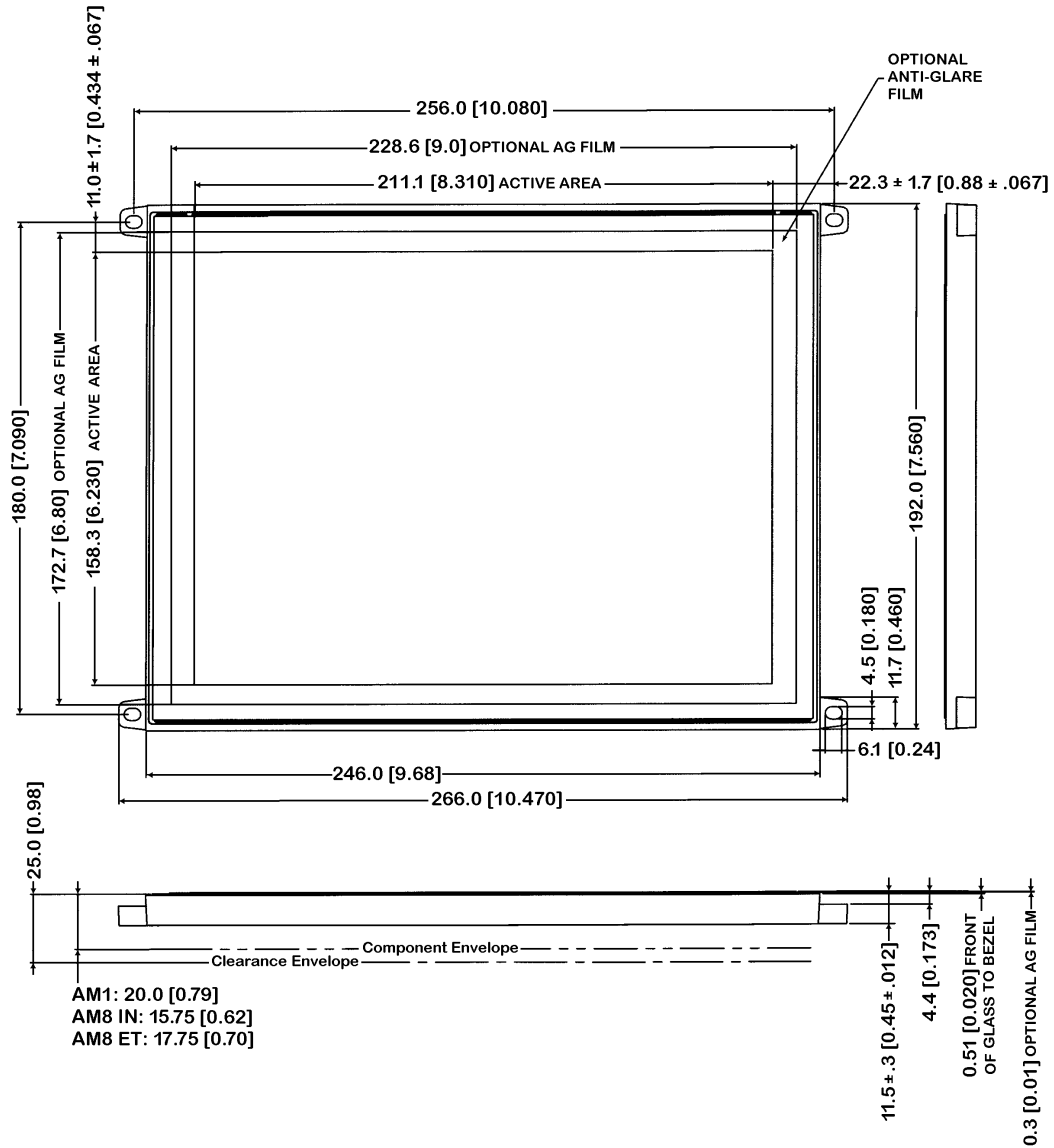

Dimensions are in millimeters, brackets are in inches.
Tolerances, unless otherwise stated, are ± 0.2 mm.

Figure 6. AM Series Dimensions.

Description of Warranty

Seller warrants that the Goods will conform to published specifications and be free from defects in material for 12 months from delivery. To the extent that Goods incorporate third-party-owned software, Seller shall pass on Seller's licensor's warranty to Buyer subject to the terms and conditions of Seller's license.

Warranty repairs shall be warranted for the remainder of the original warranty period. Buyer shall report defect claims in writing to Seller immediately upon discovery, and in any event, within the warranty period. Buyer must return Goods to Seller within 30 days of Seller's receipt of a warranty claim notice and only after receiving Seller's Return Goods Authorization. Seller shall, at its sole option, repair or replace the Goods.

If Goods were repaired, altered or modified by persons other than Seller, this warranty is void. Conditions resulting from normal wear and tear and Buyer's failure to properly store, install, operate, handle or maintain the Goods are not within this warranty. Repair or replacement of Goods is Seller's sole obligation and Buyer's exclusive remedy for all claims of defects. If that remedy is adjudicated insufficient, Seller shall refund Buyer's paid price for the Goods and have no other liability to Buyer.

All warranty repairs must be performed at Seller's authorized service center using parts approved by Seller. Buyer shall pay costs of sending Goods to Seller on a warranty claim and Seller shall pay costs of returning Goods to Buyer. The turnaround time on repairs will usually be 30 working days or less. Seller accepts no added liability for additional days for repair or replacement.

If Seller offers technical support relating to the Goods, such support shall neither modify the warranty nor create an obligation of Seller. Buyer is not relying on Seller's skill or judgment to select Goods for Buyer's purposes. Seller's software, if included with Goods, is sold as is, and this warranty is inapplicable to such software.

SELLER DISCLAIMS ALL OTHER WARRANTIES, EXPRESS OR IMPLIED, INCLUDING BUT NOT LIMITED TO, IMPLIED WARRANTIES OF MERCHANTABILITY AND FITNESS FOR A PARTICULAR PURPOSE.

Ordering Information

Product	Part Number	Description
EL640.480-AM1	996-0268-00LF	10.4" diagonal, 640x480 VGA display. 0 to 55°C operating temperature
EL640.480-AM1 AG	996-0268-02LF	EL640.480-AM1 with anti-glare film
EL640.480-AM8 IN	996-0268-27LF	10.4" diagonal, 640x480 VGA display. -25 to 65°C operating temperature, analog dimming, low profile, optional 24 V supply
EL640.480-AM8 ET	996-0268-16LF	10.4" (mm) diagonal, 640x480 VGA display. -40 to 65°C operating temperature, analog dimming, low profile, optional 24 V supply, locking data and power connector.
EL640.480-AM8 ET CC	996-0268-20LF	EL640.480-AM8 ET with conformal coating
EL640.480-AM8 ETL	996-0268-28LF	10.4" (mm) diagonal, 640x480 VGA display. -60 to 65°C operating temperature, analog dimming, low profile, locking data and power connector.
EL640.480-AM8 ETL CC	996-0268-29LF	EL640.480-AM8 ETL with conformal coating

Design and specifications are subject to change without notice.

Planar Systems continues to provide optional, and in many cases custom, features to address the specific customer requirements. Consult Planar Sales for pricing, lead time and minimum quantity requirements.

Support and Service

Planar Systems, Inc. is a US company based in Beaverton, Oregon and Espoo, Finland, with a world-wide sales distribution network. Full application engineering support and service are available to make the integration of Planar displays as simple and quick as possible for our customers.

RMA Procedure: For a *Returned Material Authorization* number, please contact Planar Systems, Inc. with the model number(s) and serial number(s). When returning goods for repair, please include a brief description of the problem, and mark the outside of the shipping container with the RMA number.

Planar Systems, Inc.

Customer Service

24x7 Online Technical Support: <http://www.planar.com/support>

Americas Support

1195 NW Compton Drive

Beaverton, OR 97006-1992

Tel: 1-866-PLANAR1 (866) 752-6271

Hours: M-F, 5am - 5pm Pacific Time

Europe and Asia-Pacific Support

Olarinluoma 9 P.O. Box 46

FIN-02201 Espoo, Finland

Tel: +358-9-420-01

Hours: M-F, 7:00am - 4pm CET

© 2004 **Planar Systems, Inc. 06/04** Planar is a registered trademark of Planar Systems, Inc.

ICE, ICEBrite, and ICEPlus are trademarks of Planar Systems, Inc.

Other brands and names are the property of their respective owners.

Technical information in this document is subject to change without notice.

020-0351-00A